

# SECTION 13

## Multipliers

VMI manufactures many high voltage multipliers, most of which are custom designed for specific requirements. The following information provides general information and basic guidance necessary for the design of a multiplier assembly.

### Outline of Multiplier Design Process:

#### I. Introduction

- *what is a multiplier?*
- *how does a multiplier work?*
- *common multiplier applications*

#### II. Assembly Type

- *half wave series multiplier*
- *half wave parallel multiplier*
- *full wave series multiplier*
- *series vs. parallel design considerations*

#### III. Other Design Concerns

- *stray capacitance*
- *corona*
- *leakage currents*
- *reasonable ranges*

#### IV. Electrical Operating Conditions

- *reasonable ranges*
- *input & output voltage*
- *output current*
- *operating frequency*

#### V. Physical Characteristics

- *size*
- *mounting*
- *terminations*

#### VI. Environmental Conditions

- *high altitude*
- *chemical exposure*
- *humidity*
- *extreme temperatures*
- *practical limits*

# MULTIPLIERS

## Design Guide

### I. Introduction

#### Introduction: What is a Multiplier?

Voltage multipliers are AC-to-DC power conversion devices, comprised of diodes and capacitors, that produce a high potential DC voltage from a lower voltage AC source. Multipliers are made up of multiple stages. Each stage is comprised of one diode and one capacitor.

#### Introduction: How Does a Multiplier Work?

The most commonly used multiplier circuit is the half-wave series multiplier. All multiplier circuits can be derived from its basic operating principles. Thus, the half-wave series multiplier circuit is shown in Figure 1 to exemplify general multiplier operation. The example shown in Figure 1 assumes no losses and represents sequential reversals of transformer ( $T_s$ ) polarity.

**FIGURE 1:**

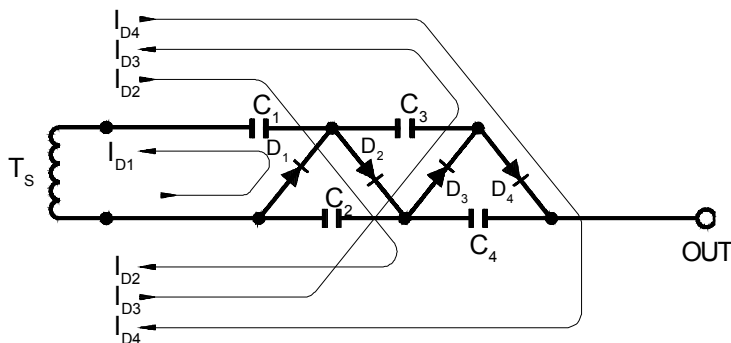

- 1)  $T_s$  = Negative Peak:  $C_1$  charges through  $D_1$  to  $E_{pk}$
- 2)  $T_s$  = Positive Peak:  $E_{pk}$  of  $T_s$  adds arithmetically to existing potential  $C_1$ , thus  $C_2$  charges to  $2E_{pk}$  thru  $D_2$ .
- 3)  $T_s$  = Negative Peak:  $C_3$  is charged to  $2E_{pk}$  through  $D_3$ .
- 4)  $T_s$  = Positive Peak:  $C_4$  is charged to  $2E_{pk}$  through  $D_4$ . Therefore, output voltage =  $E_{pk} \times N$  (where  $N$  = the number of stages).

### General...

- a multiplier is an ac-to-dc power conversion device.
- how does it work?
- common applications  
CRT's, lasers, X-ray systems, TWT's, ion pumps, electrostatic systems, more...

INTRODUCTION

13

# Multipliers: Design Guide

Introduction (continued)

## Introduction: Common Multiplier Applications

Originally used for television CRT's, voltage multipliers are now used for lasers, x-ray systems, traveling wave tubes (TWT's), photomultiplier tubes, ion pumps, electrostatic systems, copy machines, and many other applications that utilize high voltage DC.

## II. Assembly Type

### Assembly Type: Half-wave Series Multiplier

#### Characteristics:

- 1) Most common circuit
- 2) Very versatile
- 3) Uniform stress per stage on diodes & capacitors.
- 4) Wide range of multiplication stages.
- 5) Low cost

FIGURE 2:

Typical 4x Circuit Schematic

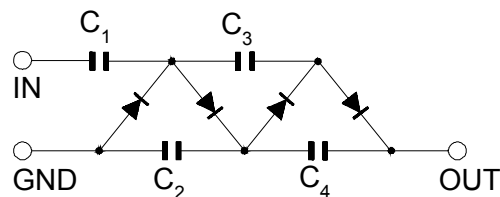

The following schematic (Figure 3) shows some of the many variations which are available for a half-wave series multiplier configuration.

FIGURE 3

A large number of stages are available:

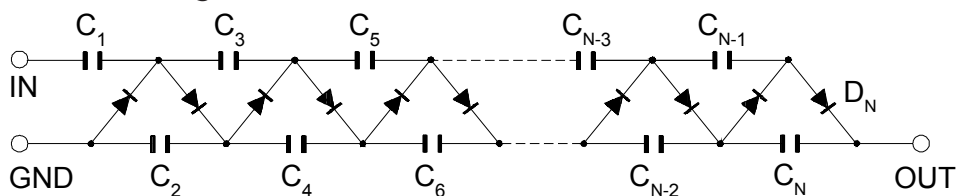

Negative Output is achieved through reversing diode polarity:

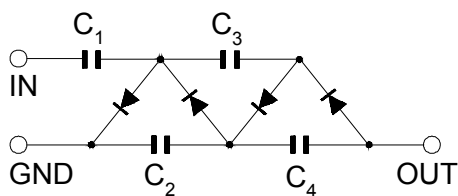

# Multipliers: Design Guide

Assembly Type (continued)

## Assembly Type: Half-wave Series Multiplier (continued)

**FIGURE 3 (continued):**

Dual polarity output voltage is achieved through joining positive and negative multipliers:

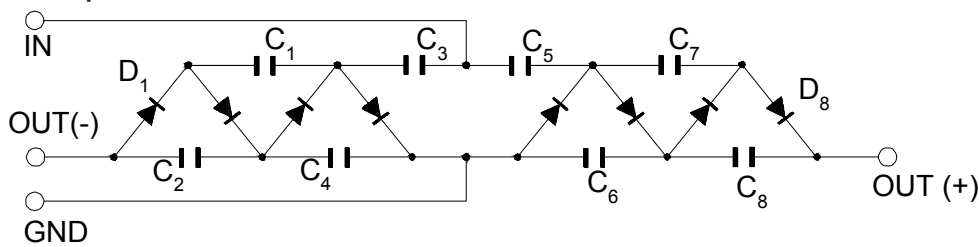

Odd or even numbers of stages can be produced:

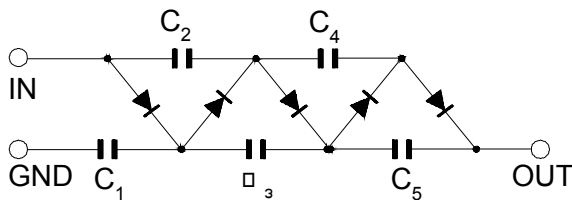

Voltage may be tapped at any point along the capacitor filter bank:

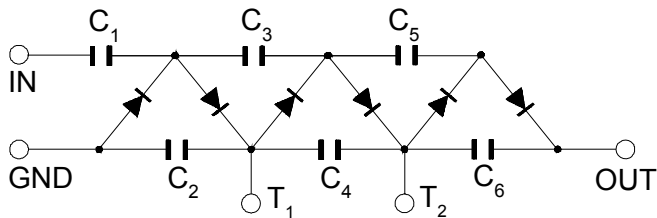

Any capacitor may be eliminated on the capacitor filter bank, if the load is capacitive:

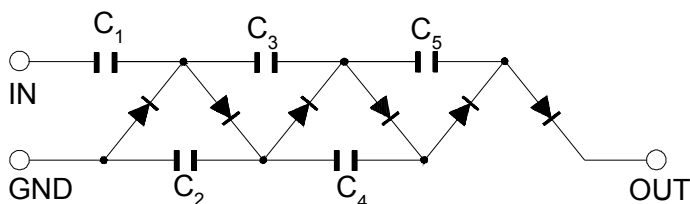

## Specify..

- half-wave series
- half-wave parallel
- full-wave series

ASSEMBLY

# Multipliers: Design Guide

## Assembly Type (continued)

### Assembly Type: Half-wave Parallel Multiplier

#### **Characteristics:**

- 1) Small size
- 2) Highly efficient
- 3) Uniform stress on diodes
- 4) Increasing voltage stress on capacitors with successive stages

**FIGURE 4:**  
**Typical Schematic**

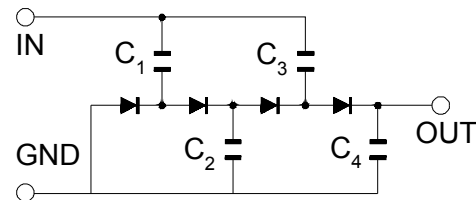

### Assembly Type: Full-wave Series Multiplier

#### **Characteristics:**

- 1) Highly efficient
- 2) Uniform stress
- 3) Increasing voltage stress on capacitors with successive stages
- 4) High power capability

**FIGURE 5:**  
**Typical Schematic**

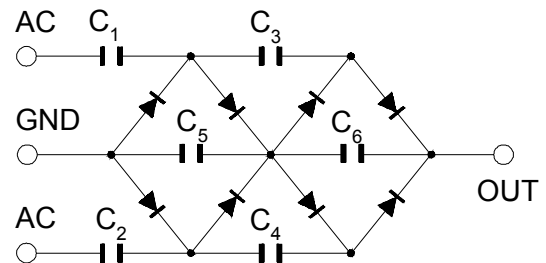

### Assembly Type: Series vs. Parallel Design Considerations

In the process of deciding which type of multiplier assembly best suits the end application, it is necessary to address the series and parallel multiplier formats.

The theory of operation is the same in both the series and the parallel multiplier assembly types. They are similar also in package volume, but are slightly different in package shape capability. Parallel multipliers require less capacitance per stage than do their series counterparts.

However, parallel multipliers also require higher voltage ratings on each successive stage. The limit on output voltage in parallel multipliers is determined by the voltage capability of the capacitors (common single-layer ceramic capacitors do not exceed 20kV).

# Multipliers: Design Guide

## Assembly Type (continued)

### Assembly Type: Series vs. Parallel Design Considerations (continued)

**Regulation Voltage:** DC output voltage drops as DC output current is increased. Regulation is the drop, from the ideal, in DC output voltage at a specified DC output current (assuming AC input voltage and AC input frequency are constant). A close approximation for series half-wave multipliers can be expressed as:

$$V_{REG} = [I(N^3 + (9N^2/4) + (N/2))] / 12fC$$

Where: N = # of stages, (1 capacitor and 1 diode = 1 stage)  
f = AC input frequency (Hz)  
C = capacitance per stage (F)  
I = DC output current (A)

Example: Calculate the regulation voltage of a 6 stage multiplier with 1000pF capacitors, 50kHz input frequency (sine wave), 1mA DC output current, 20kV DC output voltage:

$$V_{REG} = [1 * 10^{-3} (6^3 + (9 * 6^2) / 4 + (6/2))] / 12 * 50000 * (1 * 10^{-9}) = 500 \text{ volts}$$

This would require increasing the input voltage 167Vp-p ( $V_{REG} / 3$  DC capacitors) to maintain 20kV DC output voltage at 1mA.

An equivalent *parallel multiplier* would require each capacitor stage to equal the total series capacitance of the AC capacitor bank. In the above example, the 3 capacitors in the AC bank would equal 1000pF/3 or 333pF. The parallel equivalent would require 333pF capacitors in each stage. (See Figure 6)

**Ripple Voltage:** Ripple voltage is the magnitude of fluctuation in DC output voltage at a specific output current (assuming AC input voltage and AC input frequency are constant). A close approximation for series half-wave multipliers can be expressed as:

$$V_{RIP} = I(N^2 + N/2) / 8fC$$

Example: Calculate the ripple voltage of a 6 stage multiplier with 1000pF capacitors, 50kHz input frequency (sine wave), 1mA DC output current, 20kV DC output voltage:

$$V_{RIP} = (1 * 10^{-3} (6^2 + 6/2)) / 8 * 50000 * (1 * 10^{-9})$$
$$V_{RIP} = 97.5 \text{ Vp-p}$$

# Multipliers: Design Guide

Assembly Type (continued)

## Assembly Type: Series vs. Parallel Design Considerations (continued)

**FIGURE 6:**

**Series Multiplier**  
(efficiency comparison  
from perfect multiplication)

OUTPUT  
VOLTAGE  
DROP  
(VOLTS)

X ( ) = # of stages  
Capacitance = 1000pF/stage  
Diodes = 12 chips/diodes  
Frequency = 25kHz

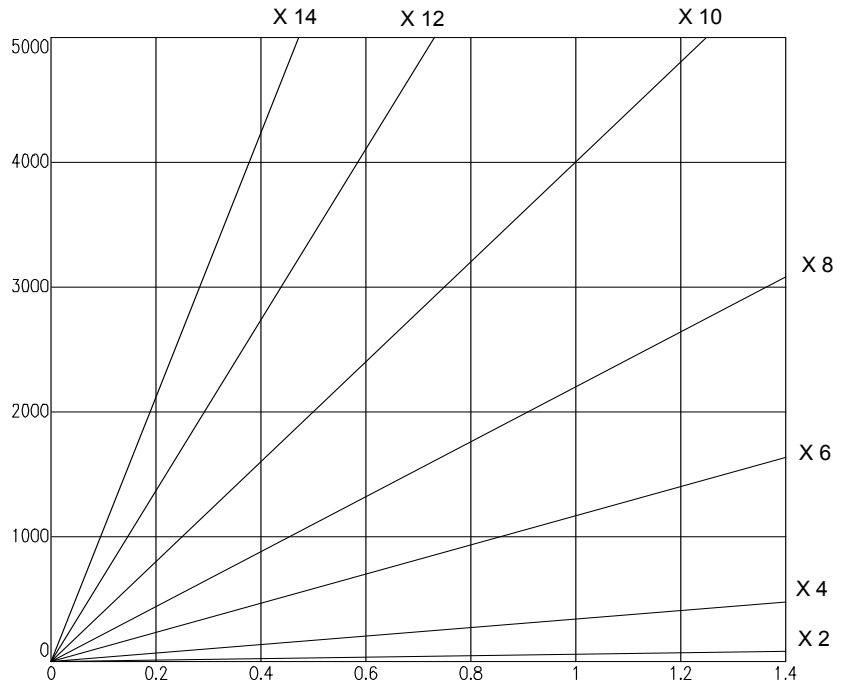

OUTPUT CURRENT (mA)

**Parallel Multiplier**  
(efficiency comparison  
from perfect multiplication)

OUTPUT  
VOLTAGE  
DROP  
(VOLTS)

X ( ) = # of stages  
Capacitance = 1000pF/stage  
Diodes = 12 chips/diodes  
Frequency = 25kHz

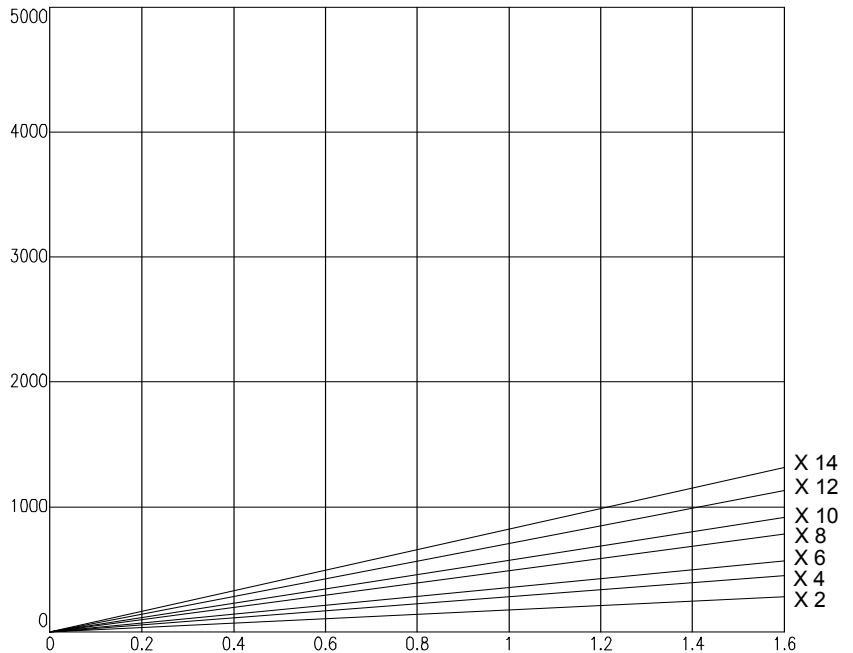

OUTPUT CURRENT (mA)

# Multipliers: Design Guide

## Other Design Concerns

### III. Other Design Concerns

#### Other Design Concerns: Stray Capacitance

Stray capacitance becomes an important consideration as input frequency increases. As the following expression indicates, an increase in frequency decreases the capacitive reactance, resulting in increased current flow through the insulating materials.

$$X_c = 1/(2\pi FC)$$

Power losses through insulation, which are negligible at 60Hz, become significant at high frequency.

#### Other Design Concerns: Corona

Corona is the result of gas ionization (air, oxygen, etc.), due to a high voltage field. This extremely destructive phenomena usually results in slow degradation of the insulating materials, causing latent failures. Careful design, consistent manufacturing processes, eliminating air entrapment in encapsulation, and a thorough understanding of what causes corona minimize this problem.

#### Other Design Concerns: Leakage Currents

Losses due to leakage in diodes, capacitors and insulation are significant considerations in applications using very low capacitor values (i.e. night vision power supplies) and in applications, which operate at high temperatures (>125°C). Figure 7 (on the following page) represents some of the factors affecting multiplier efficiency.

### Consider...

- stray capacitance
- corona
- leakage currents

CONCERNS

13



# Multipliers: Design Guide

## Other Design Concerns (continued)

### Other Design Concerns: Leakage Currents (continued)

**FIGURE 7:**

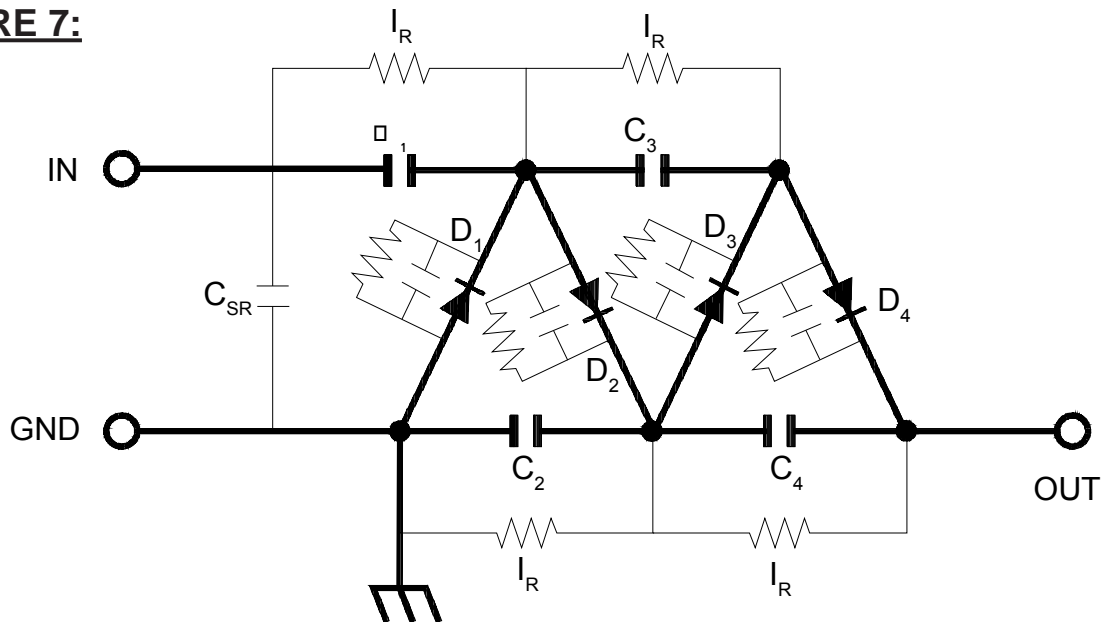

## IV. Electrical Operating Conditions

### Electrical Operating Conditions: Reasonable Ranges

Practical limits do exist, which determine multiplier design and application. Here are some typical rules of thumb for the most commonly used VMI multipliers:

- 1) AC Input Voltage: 0 to 15kV p-p
- 2) AC Input Frequency: 5kHz to 100kHz
- 3) DC Output Voltage: 1kV to 150kV
- 4) DC Output Power: 0 to 50W

# Multipliers: Design Guide

## Electrical Operating Conditions (continued)

### Electrical Operating Conditions: Reasonable Ranges (continued)

The following chart can be used to determine reasonable ranges for VMI multipliers, utilizing rugged epoxy encapsulation and single layer ceramic capacitors. Input frequency is assumed to be from 5kHz to 100kHz.

DC Output Voltage VDC	Output Power W	AC Input Voltage VAC (p-p)	Half Wave	Full Wave	Other Type Caps	Other Type Encap.
1k	0-50	200-1000	X			
	50-200	500-1000		X		
	>200	500-1000		X	X	X
2.5k	0-50	250-2500	X			
	50-200	1000-2500		X		
	>200	1000-2500		X	X	X
5k	0-50	250-5000	X			
	50-200	2500-5000		X		
	>200	2500-5000		X	X	X
10k	0-50	2500-10000	X			
	50-200	5000-10000		X		
	>200	5000-10000		X	X	X
20k	0-50	2500-10000	X			
	50-200	5000-10000		X		
	>200	5000-10000		X	X	X
30k	0-50	2500-10000	X			
	50-200	5000-10000		X		
	>200	5000-10000		X	X	X
50k	0-30	5000-10000	X			
	30-100	5000-10000		X		
	>100	5000-15000		X	X	X
75k	0-30	7500-15000	X			
	>30	>5000		X	X	X
100k	0-30	7500-15000	X			
	>30	>5000		X	X	X
150k	0-30	7500-15000	X			
	>30	>5000		X	X	X

Note: Multipliers are available that exceed the limits (as listed on the previous page), but may require other types of capacitors, encapsulation, etc.

### Specify..

- input voltage
- output voltage
- output current
- operating frequency
- output regulation
- output ripple

ELECTRICAL

# ***Multipliers: Design Guide***

## ***Electrical Operating Conditions (continued)***

---

### **Electrical Operating Conditions: Input and Output Voltage**

The input voltage is usually specified as peak or peak-to-peak voltage. The theoretical no-load output voltage is equal to the number of stages times the peak input voltage. In most cases, the output voltage will be reduced from the theoretical value due to the effects of regulation and stray capacitance.

In most applications, the output voltage from the multiplier is a primary requirement. The input voltage may need to be increased to provide the required output voltage. Care must be taken to insure that the voltage stresses on the components do not exceed ratings during multiplier operation at maximum output voltage and current.

### **Electrical Operating Conditions: Output Current**

For typical multipliers, output current can range from 1 $\mu$ A to 5mA. Due to the effects of regulation, output current can affect the voltage stresses on a multiplier's diodes and capacitors. Since regulation is directly proportional to output current, and as input voltage is usually increased to compensate for regulation, the diodes and capacitors near the input side of the multiplier will be subjected to higher voltage stress at higher output currents.

For higher current ratings, it is important to insure that the diodes' junction temperature does not exceed 125°C. A thermal analysis may be necessary to evaluate junction temperature. Typically, for output currents less than 1.0mA, the power dissipated in the diodes is low enough to prevent overheating.

### **Electrical Operating Conditions: Operating Frequency**

The lower the operating frequency for a multiplier, the larger its capacitors will need to be to maintain electrical performance. For low frequency multipliers, the operational characteristics must be calculated to determine feasibility.

The upper limit to operating frequency will be affected by diode recovery time, stray capacitance, and inductance effects.

# Multipliers: Design Guide

## Electrical Operating Conditions (continued)

### Electrical Operating Conditions: Operating Frequency

Diode recovery time can be a factor at frequencies above 100kHz. The effects of capacitance and inductance will depend on component layout, potting material used, and the choice of components.

## V. Physical Characteristics

### Physical Characteristics: Size

Custom multiplier assemblies can usually be constructed in a wide variety of shapes and sizes to meet customer needs. The customer may also specify special physical characteristics, provided such specifications do not compromise design constraints. Actual design of the package size/shape must account for internal mechanical stresses and voltage isolation issues.

Clearly defining the dimensions and necessary tolerances is very helpful. When the specific shape and/or size is not defined, as much information as possible should be provided regarding the enclosure where the part will be installed and/or the customer's preferred physical characteristics. Typically, packaging that is "as small as possible", is desired. However, an indication of preferences and expectations, with respect to package size, will aid in the development of a suitable package design.

### Physical Characteristics: Mounting

The preferred end-application mounting or installation provisions need to be specified. Through holes, integral threads, encapsulated inserts, pcb mount and suspension are some examples of mounting techniques.

## Specify..

- package size & shape
- mounting requirements
- terminations

PHYSICAL

13

# ***Multipliers: Design Guide***

## ***Physical Characteristics (continued)***

---

### **Physical Characteristics: Terminations**

Multiplier assemblies can have a large variety of terminations. Some possibilities include the turret terminal, bus wire, high voltage leads, high voltage connectors, inserts, pcb pins, or combinations of these configurations. Special terminal plating requirements should be noted as required.

## **VI. Environmental Conditions**

### **Environmental Conditions: High Altitude**

High altitudes can amplify what would, at lower altitudes, be relatively benign design issues. For example, some dielectric materials will outgas in low pressure or vacuum installations, causing degradation of the dielectric and/or contamination from insulating film deposition. Also, corona problems will generally vary non-linearly with increased altitude.

### **Environmental Conditions: Chemical Exposure**

The level of exposure an assembly receives to various chemicals should be identified if known. Many applications use dielectric oils or gases to surround the custom multiplier assembly. While these materials can provide excellent isolation, reduced corona effects, minimal mechanical stresses, and usually good cooling, they can also damage or degrade some encapsulants and remove assembly labeling. As such, materials compatibility must be addressed during the design stage.

### **Environmental Conditions: Humidity**

Environments with high humidity can sometimes cause certain types of dielectric materials to absorb moisture. Also, humidity severely limits the voltage isolation capabilities of air-insulated applications.

As a result, it may be necessary to overpot, or otherwise insulate any exposed high voltage connections.

# Multipliers: Design Guide

## Environmental Conditions (continued)

### Environmental Conditions: Extreme Temperature

Assembly exposure to high or low temperature extremes requires special consideration. This is due to the electrical and mechanical effects of the materials used in the assembly construction. For example, very high temperature extremes, such as in excess of 150°C, can significantly reduce the voltage isolation capabilities of some encapsulants.

Additionally, high temperatures can induce significant mechanical stresses, due to mismatches in material thermal expansion coefficients. (See Table 1 in Section 12).

Similarly, very low temperature extremes can induce mechanical stresses due to material thermal expansion mismatches. Low temperatures can also cause radical changes in the physical characteristics of the encapsulant, making it brittle, or causing the encapsulant to exhibit non-linear shrinkage effects. (See Table 2 in Section 12)

### Environmental Conditions: Practical Limits

Practical limits do exist, which determine multiplier design and application. Here are some environmental rules of thumb for the most commonly used VMI multipliers:

- 1) Operating Temp Range: -55°C to +125°C
- 2) Relative Humidity: 0 to 100%
- 3) Altitude: 0 to space

Note: Altitude and humidity affect materials, terminations, plating, etc. Please specify.

## Identify..

- high altitude
- chemical exposure
- humidity
- extreme temperature

ENVIRONMENT

13

# MULTIPLIER ASSEMBLY

## Design Specification Sheet

Company:	Customer P/N:
Engineer(s):	VMI Part Number:
Telephone:	Fax:
Due Date:	Qty/Usage/Time Span:
Target Price:	Program/Application:
Quantity to Quote:	Assembly Type:

Number of Stages:
Input Voltage: (pk-pk)
Output Voltage:
Output Ripple:
Output Current:
Output Regulation:
Operating Frequency:
Size (Max/Preferred):
Mounting:
Terminations:
Non-Op Temp:
Operating Temp:

Special Requirements:
-----------------------

*(Attach/Provide a Sketch)*